



REFRIGERATED COUNTER

Under Counter Refrigerator

UCR-48

FEATURES

- Precision ventilated refrigeration system keeps food at safe temperature.
- Electronic control system makes it easy to adjust temperature set point and defrost frequency.
- Self-closing doors with 90 degree stay-open feature. Locks and keys included.
- Preinstalled heavy duty casters with brakes.
- Removable installation board makes it easy to access condenser coil for cleaning and service.
- Top Lighting Canopy
- Vertical LED Lighting



WARRANTY

1 Year Parts and Labor

CERTIFICATIONS



SPECIFICATIONS

MODEL	Dimensions (in)			Voltage	Amp	Plug Type	Temperature	Shelves (Weight)	Capacity cu.ft. (Liters)
	Length	Depth	Height						
UCR-48	48"	29.9"	35.2"	110/60Hz	1.4	5-15P	33°F to 41°F	2	12.9 (365L)

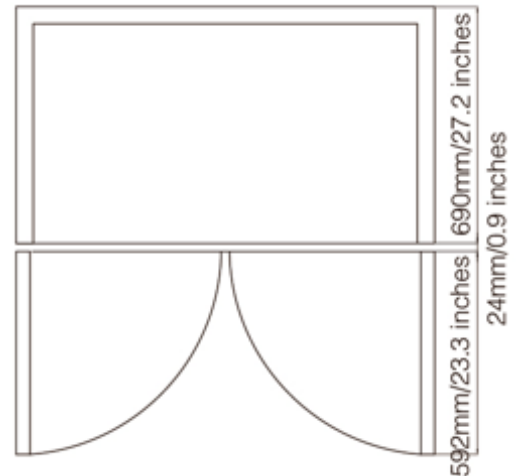
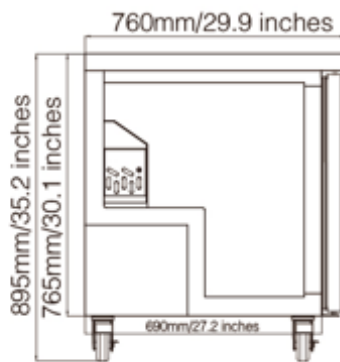
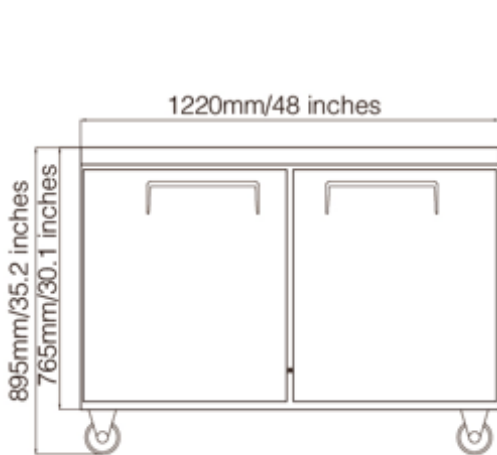

Iron Equipment reserves the right to make changes to the design or specifications without prior notice.

⚠ WARNING: This product can expose you to chemicals including lead, which are known to the State of California to cause cancer, birth defects, or other reproductive harm. For more information, go to www.p65warnings.ca.gov.